

Gastrostomía – Nutrición Enteral

Index:

- Page 3: G Tube 2 and 3 way with ENFit Adaptor
- Page 4-5: G Button
- Page 6: Extension Feed set
- Page 7: Jejunal 2 and 3 way
- Page 8: Stoma measuring device
- Page 9: NG tube ENFit Adaptor
- Page 10: PEG

La **nutrición enteral** es una técnica especial de alimentación. Consiste en administrar los diferentes elementos nutritivos a través de una sonda, colocada de tal forma que un extremo queda en el exterior y el otro en distintos tramos del [tubo digestivo](#) como el estómago, duodeno o yeyuno, suprimiendo las etapas bucal y esofágica de la [digestión](#). Este tipo de soporte nutricional está indicado cuando no es posible una adecuada alimentación oral voluntaria, siempre que la capacidad del aparato digestivo permita absorber los [nutrientes](#).

Tubos G de 2 y 3 vias con Adaptador ENFit



ERD =External Retention Device

- Round Flat
- Round with cushions
- 90 Degrees

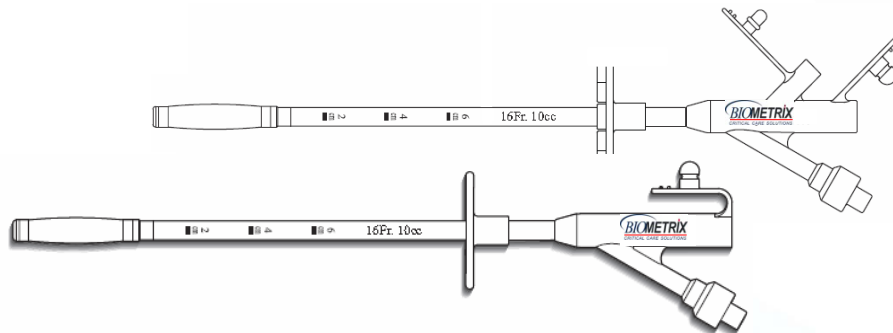

Boton G de Bajo Perfil (G-Button)

G-Button compatible with Mic-Key®









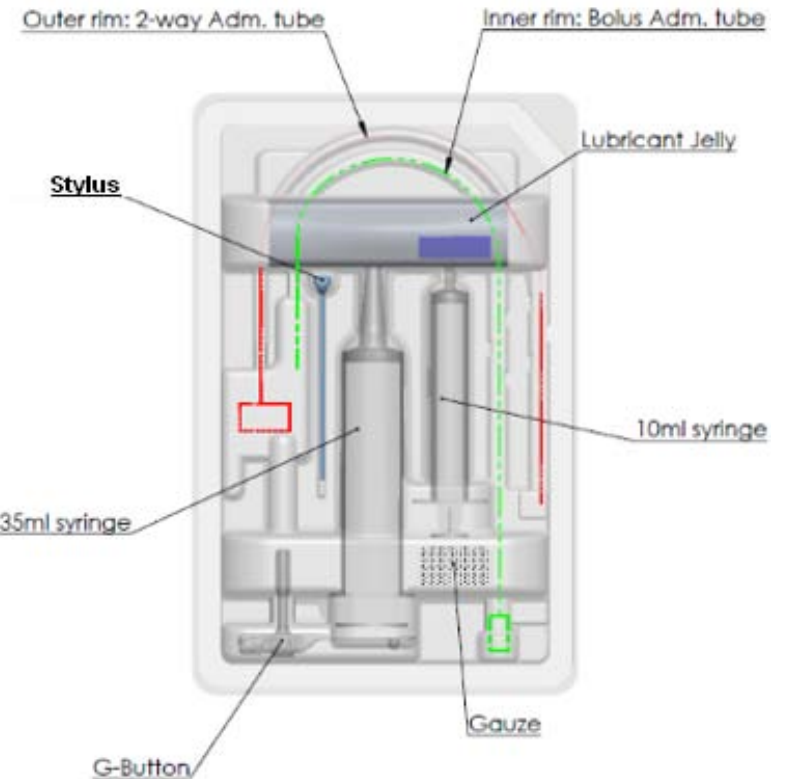
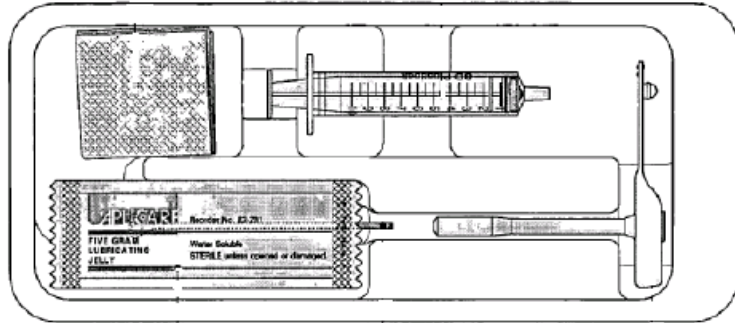

Length (mm) \ O.D. (Fr)	8	10	12	15	17	20	23	25	27	30	35	40	45	50	55	60	65
12	●	●	●	●	●	●	●	●	●	●	●	●	●	●			
14	●	●	●	●	●	●	●	●	●	●	●	●	●	●	●	●	●
16	●	●	●	●	●	●	●	●	●	●	●	●	●	●			
18	●	●	●	●	●	●	●	●	●	●	●	●	●	●	●	●	
20	●	●	●	●	●	●	●	●	●	●	●	●	●	●			
24	●	●	●	●	●	●	●	●	●	●	●	●	●	●			

* Mic/Key® is a registered trademark of Kimberly Clark Worldwide, Inc. Degania Silicone Ltd. is not associated or affiliated with Kimberly Clark Worldwide, Inc., and Kimberly Clark Worldwide, Inc. have not sponsored or approved any products sold by Degania Silicone Ltd.

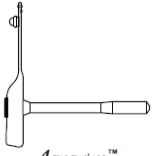
G Button Mini & Standard kit

compatible with Mic-Key®

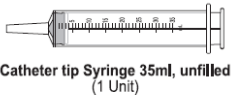
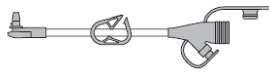

 Gastrostomy Button Kit			Feeding Set Compatibility		
 Aquarius™ Gastrostomy Button (1 Unit)	 Stylus (1 Unit)	 Gel Pack sachet of aqueous gel for lubrication. (1 Unit)	 Gauze Pad to wipe off any excess gel and clean up the stoma site. (2 Units)	WHITE RING  Use Mic-Key® compatible feeding sets	
 Catheter tip Syringe 35ml, unfilled (1 Unit)	 2-Way Feeding Set, Right-angle Connector (1 Unit)				
 Slip tip Syringe 10ml, unfilled (1 Unit)	 Universal Feeding Set, Straight Connector (1 Unit)				

Set de Extension para Botones de Bajo Perfil para Gastrostomía



Secure Lock Connectors	
Right-angle 	Straight

Funnels Feeding Connector				
Universal (Bolus) 	ENLock 	Male Luer 	PGLock 	2Way Port



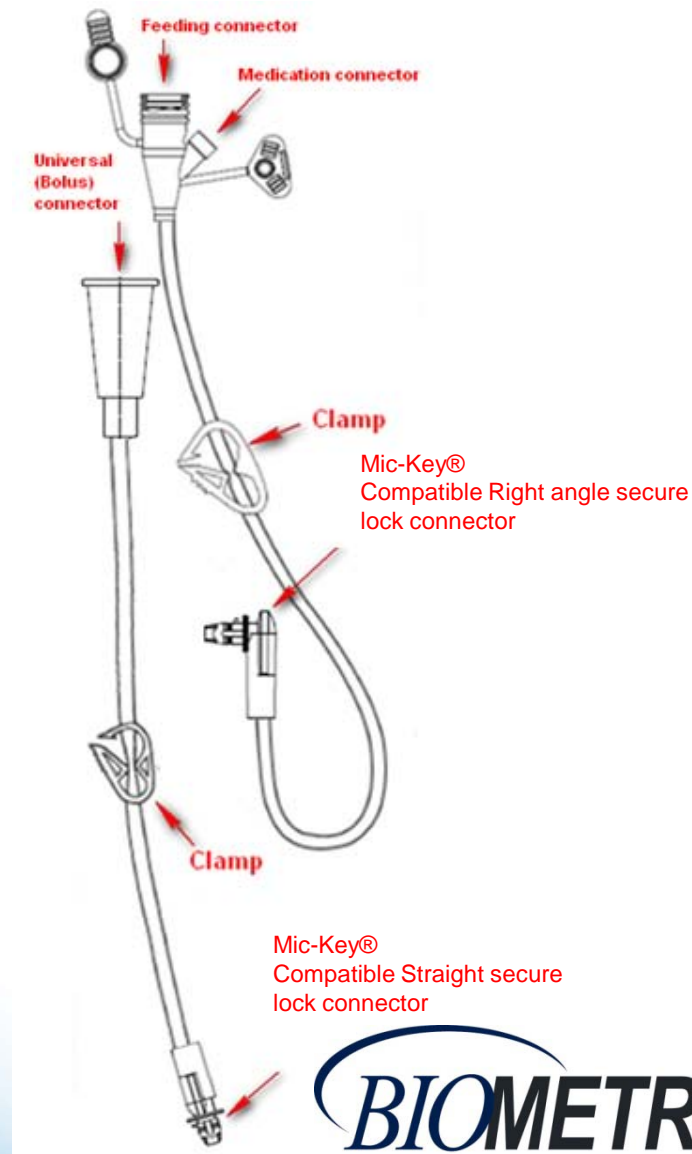

Available lengths: 30cm & 60cm





Todos los sets para nutrición enteral son exentos de DEHP



All the above feeding sets are available with either feeding media connector.

Feeding Connector	Article Description
	<p>2Way Port</p> <p>The 2Way feeding port set is intended to be used for continuous feeding.</p>
	<p>ENLock connector</p> <p>Ensures that only enteral nutrition can be delivered through enteral nutrition delivery system. (Cannot be used with IV system "Luer" connectors)</p>
	<p>Male Luer connector</p> <p>This set must only be used with Female Luer syringes for Oral/Enteral feeding.</p>
	<p>PGLock connector</p> <p>Prohibits connection from and to IV lines.</p>
	<p>Universal (Bolus) feeding</p> <p>The Bolus feeding set is intended for bolus feeding, administering medication, or flushing the G-Button with warm water.</p>

All the feeding sets below are available in two lengths: 30cm (12") or 60cm (24").
 All the feeding sets below are available with either a right-angle secure lock connector or a straight secure lock connector. (See table 1.)

Secure Lock Connector	Article Description
	Right-angle
	Striaight

Sonda de Alimentación Yeyunal - de 2 y 3 vías (GT)

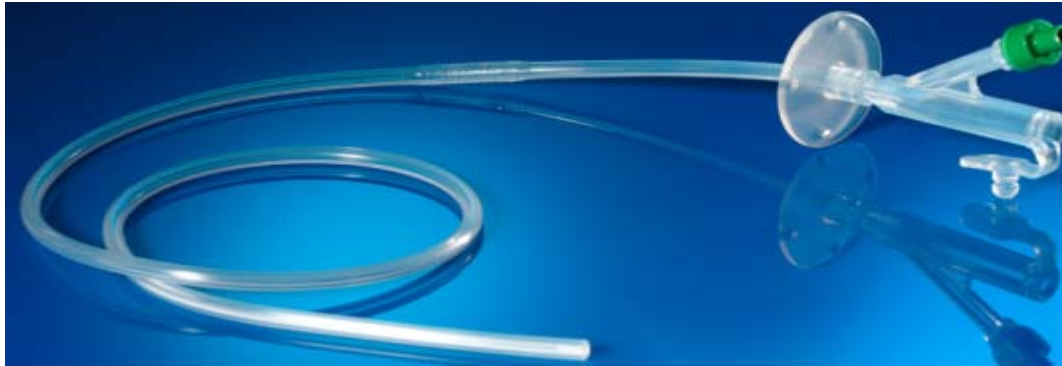

with ENFit Adaptor



Sonda de Alimentación Yeyunal- J Tube)

2-Way J Tubes:

Está diseñada para pacientes que requieren alimentación yeyunal y descompresión gástrica simultánea

9 El set contiene:

Paquete de rotación interna de silicona

Dispositivo de Medición del Estoma



Dispositivo de medición del estoma

Comprende un eje tubular con escala graduada, un embudo con una válvula de inflado y un globo de retención. El artículo está disponible en tamaño de 12 FR.

El dispositivo de medición del estoma está diseñado para determinar la profundidad (longitud) de una gastrostomía bien establecida con el fin de ayudar en la selección de la longitud apropiada del botón de gastrostomía (G-Button).

ENFit single adaptor
(Pediatric)



PU Tether



Cap - Female ENFit



Y ENFit male adaptor

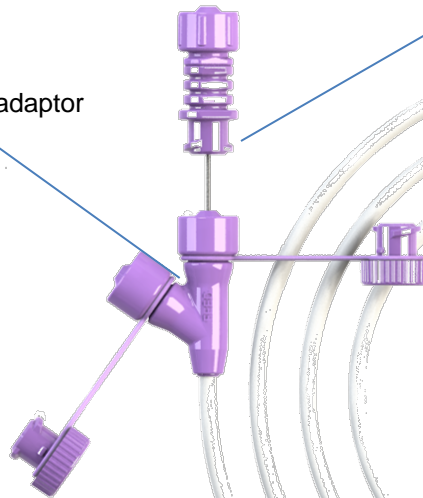

Stylet with ENFit male
and Female adaptor holder.
Adaptor type "Flow Through"

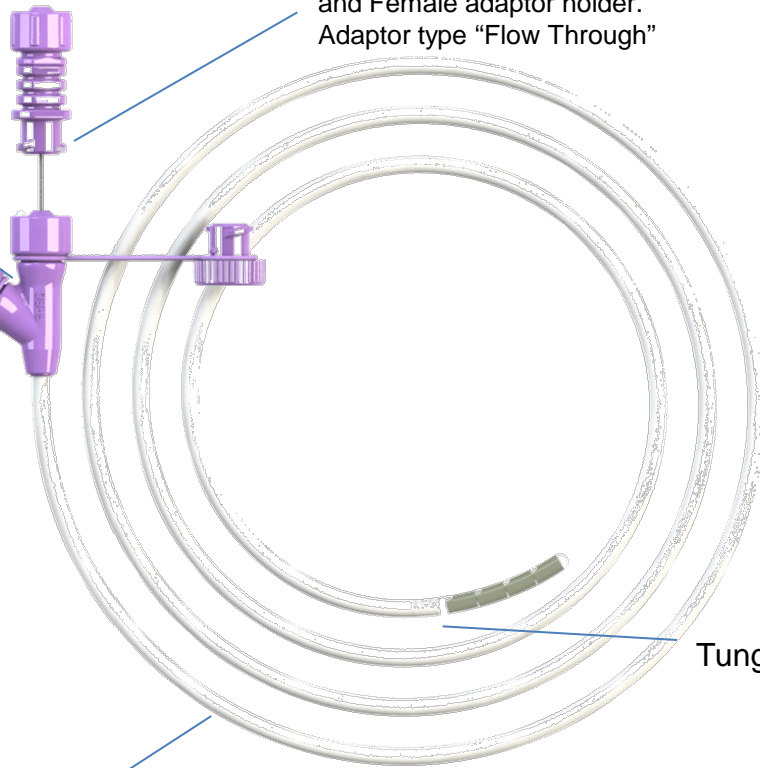

Tungsten tip

PU Tube fully
radiopaque 5-18Fr
Hydrophilic coating



Gastrostomy feeding tube Button

<http://www.youtube.com/watch?v=ZG2ydqI4Iss&feature=relmfu>

<http://www.youtube.com/watch?v=gfreaMj0IEY>

My MIC-KEY* Tube

<http://www.youtube.com/user/mymickeytube>

NG tube

<http://www.youtube.com/watch?v=xUfYHp7rbS8&feature=related>

